

KE-436C

Electronic Lockstitch Pattern Tacker with Stepping Foot and Programming function

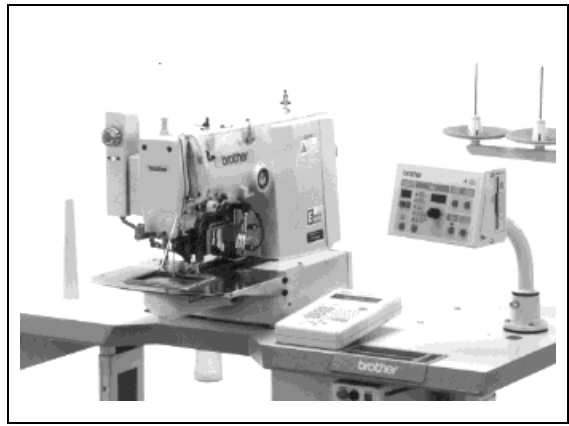

Specifications

Stitch formation	Single needle lock stitch
Maximum sewing speed	2,500 rpm (Pitch 3 mm)
Maximum pattern size (X x Y)	100 x 60 mm max.
Feed mechanism	R-θIntermittent feed mechanism (pulse-motor driven mechanism)
Stitch length	0.1 – 10.0 mm
No. of stitches	Variable
Maximum number of stitches	20,000 stitches (One pattern)
Work clamp lifter	Pneumatic type
Work clamp height	25 mm max.
Rotary hook	Shuttle hook (Shuttle hook 2, optional)
Wiper device	Standard equipment
Thread trimmer device	Standard equipment
Thread take-up device	Standard equipment
Stepping foot lift amount	18 mm
Stepping foot stroke	0 mm, 3 – 8 mm
Safety device	Built-in stopping mechanism
Data storage method	3.5 floppy disk 2HD / 1.44MB, 2DD
Motor	Three-phase 400 W induction motor
Weights	Machine head: 56 kg, Operation panel: 2.8 kg, Control box: 9 – 19 kg (depending on destination)
Power source	Single-phase 110V, 220 – 230, 240V 3-phase 220 - 230, 380, 400 V Maximum electric power consumption; 600 VA

Main use

- *Patterns up to a maximum size of 100 mm x 60 mm can be sewn.
For plain stitching of small articles, curtain darts, etc.
- *Two-stage work clamp, light work clamp and inner clamping device (optional) can be used.
For attaching items, sewing labels, etc.

Optional parts Programmer

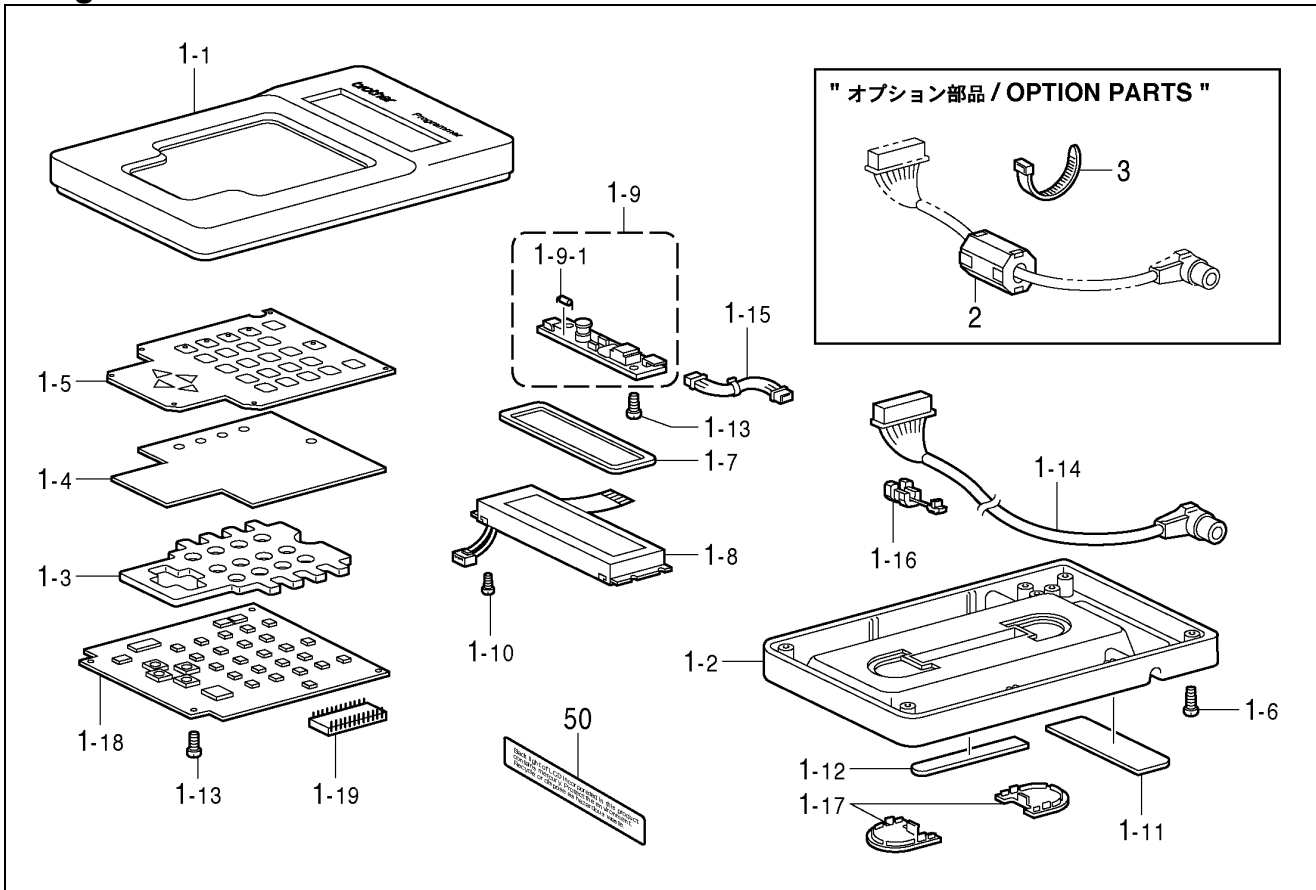

Ref. No.	Part name	Part code	Q'ty
1	Programmer assy	S43249-101	1
1-1	Programmer top cover	S43250-100	1
1-2	Programmer lower cover	S43251-000	1
1-3	Keyboard spacer	S43252-000	1
1-4	Keyboard rubber sheet	S43253-000	1
1-5	Keyboard sheet	S43254-100	1
1-6	Tapping screw, pan V M3 × 10	037301-015	1
1-7	LCD cover	S43255-000	1
1-8	LCD	S43256-000	1
7	Inverter, LCD :F1A	S59652-000	1
1-9-1	Micro fuse, 1A	S59660-000	1
1-10	Tapping screw, pan V M3 × 6	037200-615	4
1-11	Magnet, A	S43271-000	1
1-12	Magnet, B	S43272-000	1
1-13	Screw, 3 × 6	037300-615	6
1-14	Programmer harness	S43267-000	1
1-15	Inverter harness	S43268-000	1
1-16	Cord bush, KR51	S43270-000	1
1-17	Programmer under cover	S43981-000	2
1-18	Programmer PCB assy	S43259-101	1
1-19	PROM programmer assy	S43269-000	1
	"Option parts"		
2	EMI core, ESD-SR-15	S40621-000	1
3	Beard band, L = 200	149809-000	1
	<For area limitation>		
50	Mercury warning label 14 × 70 P2	S52582-001	1



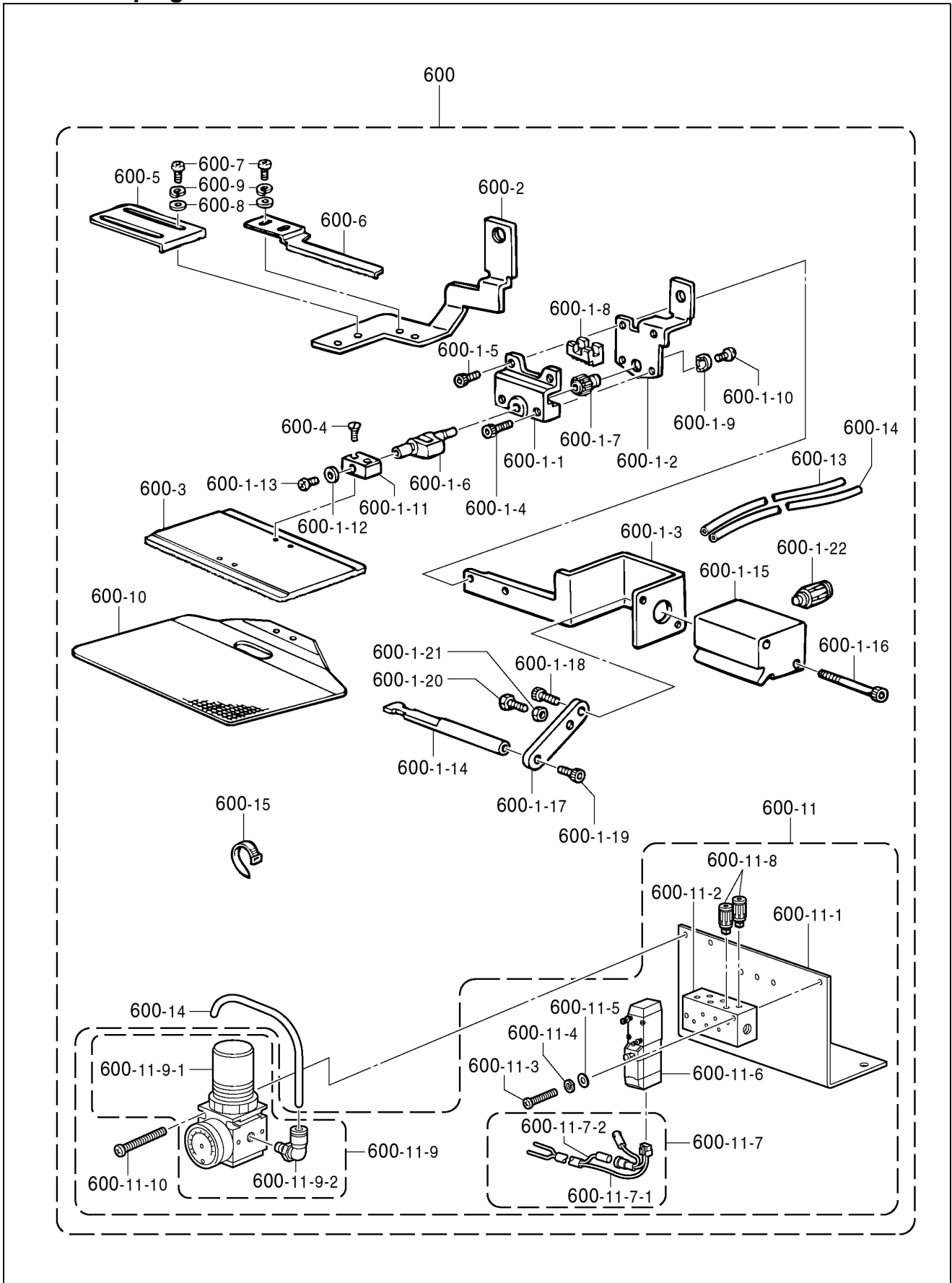









**Optional device
Inner clamping device**



Optional device
Inner clamping device

Ref. No.	Part name	Part code	Q'ty
600	Inner clamp device set	SA0709-001	1
600-1	Work clamp crank assy, 434E	S42007-001	1
600-1-1	Work clamp crank holder, A	S12634-009	1
600-1-2	Work clamp crank holder, B	S42008-001	1
600-1-3	Reverse cylinder base	S42019-001	1
600-1-4	Bolt, socket M3 × 12	018301-236	2
600-1-5	Bolt, socket M3 × 8	018300-836	2
600-1-6	Work clamp crank, LA	S05665-001	1
600-1-7	Reverse gear	154235-001	1
600-1-8	Reverse rack	154236-001	1
600-1-9	Washer	145087-001	1
600-1-10	Set screw, SM3.18	149831-101	1
600-1-11	Work clamp plate holder, L	154237-001	1
600-1-12	Washer, plain S3.5	025350-132	1
600-1-13	Screw, SM3.57 – 40 × 5	100242-003	1
600-1-14	Reverse rod	S42020-001	1
600-1-15	Reverse cylinder	S12639-001	1
600-1-16	Bolt, socket M3 × 35	S12642-009	2
600-1-17	Reverse shaft joint	S42021-001	1
600-1-18	Bolt, socket M3 × 8	018300-836	1
600-1-19	Bolt, socket M3 × 8	018300-836	1
600-1-20	Bolt, M5 × 12	017501-216	1
600-1-21	Nut, 2M5	021500-216	1
600-1-22	Half union, ;Q4M5	S18415-101	2
600-2	Outer work clamp	S42009-101	1
600-3	Work clamp plate blank, A	154256-101	1
600-4	Screw, flat SM3.18	117291-002	2
600-5	Positioning plate, L	154252-001	1
600-6	Positioning plate, R	154253-001	1
600-7	Screw, pan SM3.57 – 40 x 5	062670-512	4
600-8	Washer, plain L3.5	025350-332	4
600-9	Washer, spring 2 – 3.5	028350-242	4
600-10	Feed plate blank, 434R1	S43459-001	1
600-11	Inner valve assy, 4	SA0048-001	1
600-11-1	Valve setting plate, 4-5H	S31570-409	1
600-11-2	Air manifold, 4	S44749-001	1
600-11-3	Screw, pan M3 × 25	062302-505	2
600-11-4	Washer, spring 2-3	028030-242	2
600-11-5	Washer, plain M3	025030-232	2
600-11-6	Solenoid valve	S43683-001	1
600-11-7	Valve harness assy, X1	S43696-100	1
600-11-7-1	Valve harness	S44746-100	1
600-11-7-2	Valve harness, 24V	S44750-100	1
600-11-8	Half union, ;Q4M5	S18415-101	2
600-11-9	Regulator assy	S45252-000	1
600-11-9-1	Regulator	S45253-000	1
600-11-9-2	Joint, 3109 – 4 - 10	S45254-000	2
600-11-10	Screw, pan M4 × 40	062404-005	2
600-12	Air tube, 4L = 300	S28741-000	1
600-13	Air tube, RV-3A L = 1600	S53118-001	1
600-14	Air tube, RV-3B L = 1600	S53118-002	1
600-15	Tying band, 1.9 × 80	228475-000	3

Different parts list

Spec. Part name	Option parts	Standard parts	Option parts
	Medium-weight materials	Heavy-weight materials	Extra heavy-weight materials
Needle hole plate 	(ϕ 2.2) S49980-001 <FM>	(ϕ 2.6) S10212-101 <E>	★
Bobbin case assy 	159610-301 <A>	152690-401 	★
	S59221-001 <LC>		
Tension spring 	154339-101 <A>	154340-101 	
	-		
Screw 	154341-001		★
	-		
Spring, anti-spin 	159612-001 <A> ★	154342-001	★
	-		
Bobbin 	159613-051 ★	154663-001 	★
	S44633-001 <LAN>		
Shuttle hook assy w/box 	SA1881-001 <A> ★	SA1882-001 	★
	SA2173-001 <LF> ★	SA1890-001 <LG>	★
Shuttle race body 	152682-101 A ★	152686-101 	★
Spring, tension 	104525-001 ★	107606-001 ★	S06548-001 <C>
Thread take-up spring 	145519-001 ★	144588-001 	★
Needle bar thread guide   A B	S41222-101 ★	S02438-001 <A> ☆	S02439-001 ★

★: Common with the LK3-B430E.

☆: Common with the BAS-311E.

Different parts list

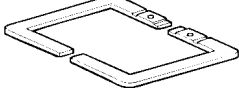
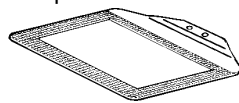
	Option parts	Standard parts	Option parts
Spec.	Medium-weight materials	Heavy-weight materials	Extra heavy-weight materials
Part name			
Needle assy	DP x 5 <#14> SA1752-014 ★	DP x 17NY <#19> SA1579-019 ★	DP x 17 <#25> SA1645-025 ☆
Needle 	DP x 5 <#14> 107415-014 ★	DP x 17 NY <#19> S37928-019 ★	DP x 17 <#25> 145646-025 ☆
Work clamp 	-	LEFT 434E SF-2 S46545-001 ----- RIGHT S434E SF-2 S46544-001	-
Feed plate 	-	434E SF-2 S44942-001	-

★: Common with the LK3-B430E.

☆: Common with the BAS-311E.

Gauge parts list

Optional gauges are listed in the following table.

Each work clamp pair is used in combination with the feed plate directly below them.

	For one-touch work clamp assy		
L	S44941-001 (434E SF)		
R	S44940-001 (434E SF)		
Work clamp			
Feed plate	S43990-001 (A)	S43991-001 (B)	S43992-001 (C)
			A: t = 0.5 B: t = 1.0 C: t = 2.0

Gauge assy, 434E MK2	
S54984-001	
Home position standard plate S52100-001 	Screw, w/socket SM4.37 S49955-001

Gauge parts list

Needle hole plate											
A	S10211-001	AF	S51449-001	BZ	S41013-001	D	S29997-001	E	S10212-101	ED	S30925-001
F	S10213-001	FD	S30926-001	FM	S49980-001	FZ	S59620-001	H	S30450-001	L	S25127-001
M	S34348-001	3 countersink S40217-001									